

Metso

Lokotrack® ST mobile solutions

Made to keep
your process
going





Asphalt recycling



Concrete demolition



Aggregates production

Reliable separation day in, day out

Metso Lokotrack® ST™ mobile screens give you high screening capacity and excellent productivity with a range of feed materials. They are highly mobile and ideal for contractors and aggregate producers who need efficient separation and versatility to handle a variety of applications. Each product in the range can be customized for your specific needs and will deliver dependable results for years to come.

From the world's leading manufacturer

Metso is the world's leading manufacturer of track-mounted crushers and screens. Our unmatched technology and engineering know-how enables us to tailor each Lokotrack® ST™ mobile screen to meet your specific needs. And, because they are designed to be flexible, its quick and easy to adapt them to meet changing market needs. You can also configure them to operate in different types of standalone and multistage crushing applications.

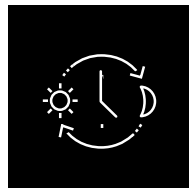

Dependability

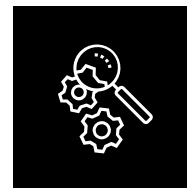

Optimized processes



Mobility



Flexible operations



Contents

Reliable separation day in, day out	2
From the world's leading manufacturer	2
Wide range of reliable mobile screens	4
Multi-use scalping screens	4
Aggregates screens	4
Optimizing multi-stage processes	6
Move with your production	6
Process automation as standard feature	6
e-Power for efficiency and savings	7
Lokotrack® ST – Selection guide	8
Mobile scalping screens	
Lokotrack® ST2.3™	10
Lokotrack® ST2.8™	12
Mobile aggregate screens	
Lokotrack® ST3.8™	14
Lokotrack® ST4.8™	16
Lokotrack® ST4.10™	18
Examples of Lokotrack® ST applications	20
Expert support, parts and services	22
Case stories	23

Wide range of reliable mobile screens

The Lokotrack® ST™ range is ideal for medium and large size contractors and it includes both multi-use scalping screens and aggregates screens. Every product features the same robust, reliable performance, and safe and simple operation. In addition, they are easy to maintain using convenient service access points.

Multi-use scalping screens

Multi-use Lokotrack ST screens are engineered to screen and scalp blasted rock, sand and gravel, recycled concrete and top soil. This makes them ideal for the production of construction and landscaping materials.

- Lokotrack ST2.3
- Lokotrack ST2.8



Aggregates screens

Lokotrack ST aggregate screens are designed to screen crushed rock, as well as sand and gravel. This makes them an excellent choice to produce aggregates for concrete and asphalt, road base, building foundations and railway ballast.

- Lokotrack ST3.8
- Lokotrack ST4.8
- Lokotrack ST4.10



e-Power for efficiency and savings

Most Lokotrack ST screens are available as e-Power versions. This enables the units to be operated using either the diesel engine or with the built-in electrical motors. The electric motors can be powered by an external electric network or, with customization, by a hybrid Lokotrack crusher equipped with an onboard diesel generator. Running your processes with external electricity or with a single diesel engine can result in significant savings for your operations.

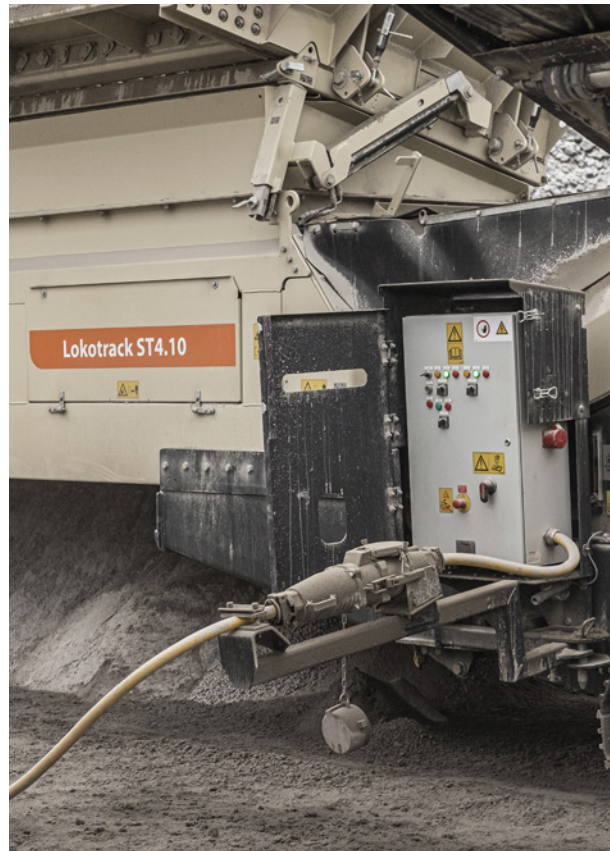

The following models are available as e-Power version:

ST2.8E
ST4.10E

ST3.8E
ST4.8E

Combine Lokotracks and optimize multi-stage processes

Lokotrack® ST products can be easily combined with other Lokotrack units, both mechanically and via their automation, for more efficient operation. Because they are easy to connect and combine, Lokotrack ST products are particularly well-suited to multi-stage processes.

Move with your production

Their on-site mobility, effortless interoperability and quick set-up make it easy for you to transport entire multi-stage chains to new work sites, or to move them to new locations on your current one. However and wherever you need to configure your multi-stage process, Lokotrack ST makes it simple.

Process automation as standard feature

To make crushing and screening process as efficient and smooth as possible, Lokotracks can be monitored via Metso IC™ automation and controlled remotely with wireless Remote IC from excavator cabin. Metso Metrics cloud-based remote monitoring and visualization service enables you to gain critical data and insight into the operational performance and maintenance needs of your fleet. Metso Metrics is a part of our Life Cycle Services with wide range of service packages to help to run your process smoothly.











Efficient screening also
as a stand-alone unit



Lokotrack® ST – Selection guide

Questions to help you select the right Metso equipment:

- What material are you processing?
- What is your capacity need?
- Do you need to produce a variety of different end products?
- How close is the site to the nearest residential area?
- How strict are the environmental requirements in the area?

	Primary scalping 	Topsoil 	Recycled waste 	Railway ballast 	Road base 	Sand & gravel 	Fine aggregates (concrete & asphalt) 	Typically combined with		
								LT jaw crusher	LT impactor crusher	Secondary LT crusher
ST2.3	●●●	●●●	●●	●●	●●	●●	●	LT96	LT1110	LT200HP
ST2.8	●●●	●●●	●●●	●●	●●	●●	●	LT116 LT120/E	LT1213(S)	LT300HP LT330D
ST3.8		●	●	●●●	●●●	●●●	●●●	LT106 LT116	LT1213(S)	LT300HP
ST4.8		●	●	●●●	●●●	●●●	●●●	LT106 LT116	LT1213(S)	LT300HP
ST4.10		●	●	●●●	●●●	●●●	●●●	LT120/E	LT1213(S)	LT300HP LT330D



	Type	Decks	Screen area top deck	Screen size	Screen working angle	Transport weight	Screen speed	Stroke	Engine power	e-Power
ST2.3	Multi-Use	2	4.6 m ² 49 ft ²	3,040 x 1,520 mm 10 x 5'	13-23°	17 t 37,500 lbs	840 rpm	up to 13 mm	55 kW 74 hp	n/a
ST2.8/E	Multi-Use	2	7.4 m ² 79 ft ²	4,860 x 1,520 mm 16 x 5'	10-17°	26 t 57,300 lbs	760 rpm	up to 15 mm	100 kW 134 hp	Yes
ST3.8/E	Aggregates	2	7.9 m ² 85 ft ²	5,480 x 1,520 mm 18 x 5'	18-30°	30 t 66,100 lbs	1,050 rpm	7-8 mm	100 kW 134 hp	Yes
ST4.8/E	Aggregates	3	7.9 m ² 85 ft ²	5,480 x 1,520 mm 18 x 5'	18-30°	32 t 70,500 lbs	1,050 rpm	7-8 mm	100 kW 134 hp	Yes
ST4.10/E	Aggregates	3	9.3 m ² 100 ft ²	6,060 x 1,520 mm 20 x 5'	18-27°	33 t 72,700lbs	950 rpm	8-9 mm	100 kW 134 hp	Yes

Lokotrack® ST2.3™

Widest screen in its size class

ST2.3™ is our most compact mobile screen for primary scalping. With its aggressive stroke, wide screen and adjustable screen angle it is ideal for general contractors with various feed materials such as topsoil and recycled concrete waste.

Large hopper

Side wall extensions to feed with wheel loader or excavator

High screening performance

- Widest screen in the class
- Aggressive stroke for efficient separation
- Supports various screening media combinations

Areas of application:

-  Primary scalping
-  Topsoil
-  Recycled waste
-  Road base
-  Fine aggregates

High fuel efficiency

CAT® C3.6 engine

Adjustable screen angle

Easy transport

Compact size and optimized weight
Hydraulic functions

Adjustable conveyor angle

Easy maintenance access

With hydraulic screen lift and large area under screen



Metso IC automation

Easy and safe process control and connectivity to other Lokotracks



**Compact size for transport¹
in a standard trailer**



Low fuel consumption







**Easy-to-use for general
contractors**



**Flexible with adjustable screen
and conveyor angles**

Technical details Lokotrack® ST2.3™

Screen	Feeder	Conveyor	Engine power options	Transport dimensions
				
<p>Size 3,040 x 1,520 mm (10' x 5')</p> <p>Screening area 4.6 m² (5.5 yd²)</p> <p>Decks 2</p> <p>Nominal capacity* 350 MtpH (385 Stph)</p> <p>Stroke Up to 13 mm</p> <p>Screening media Plate grizzly, Finger grizzly, Punch plate</p>	<p>Type Belt feeder</p> <p>Hopper volume 4.5 m³ (5.9 yd³) standard 5.5 m³ (7.1 yd³) extension</p> <p>Loading height 2,500 - 3,000 mm (8' 2" - 9' 10")</p> <p>Loading width 2,300 mm (7' 6")</p> <p>Max feed size 400 mm (16")</p>	<p>Conveyor oversize width 1,200 mm (47")</p> <p>Side conveyor midsize width 650 mm (26") Adjustable discharge height</p> <p>Side conveyor undersize width 650 mm (26") Adjustable discharge height</p>	<p>Model CAT® C3.6</p> <p>StageV/Tier4F/Tier3 100 kW (134 hp)</p> <p>Fuel tank 260 l (69 gal)</p> <p>Hydraulic oil 100 l (26 gal)</p>	<p>Length 11,950 mm (39' 4")</p> <p>Width 2,880 mm (9' 5")</p> <p>Height 2,550 mm (8' 5")</p> <p>Weight 17,000 kg (37,500 lbs) available for ship container transportation</p>

*Capacity depends on application (required end products, feed material characteristics and size, moisture etc.)



Widest screen in its class.



Compact size for easy to transport.



Multi-use for primary scalping and screening.



Automate process control and one button on/off.



"The ST2.3 is easy to use with the Metso IC™ and consumes fuel only seven liters per hour."
Stig Johansson, J.Koskenmäki, Finland.

Lokotrack® ST2.8™ & ST2.8E

Biggest eccentric throw on the market

ST2.8™ offers high capacity with most aggressive stroke on the market that makes it very efficient in scalping sticky material like topsoil, river gravel or slag.

Feeder start/stop

To be connected with Lokotrack LT crusher

Large hopper with side walls

To be fed with wheel loader or excavator

Separation of metal particles

- Magnetic drums
- Magnetic separator

Areas of application:

-  Primary scalping
-  Topsoil
-  Recycled waste
-  Road base
-  Fine aggregates

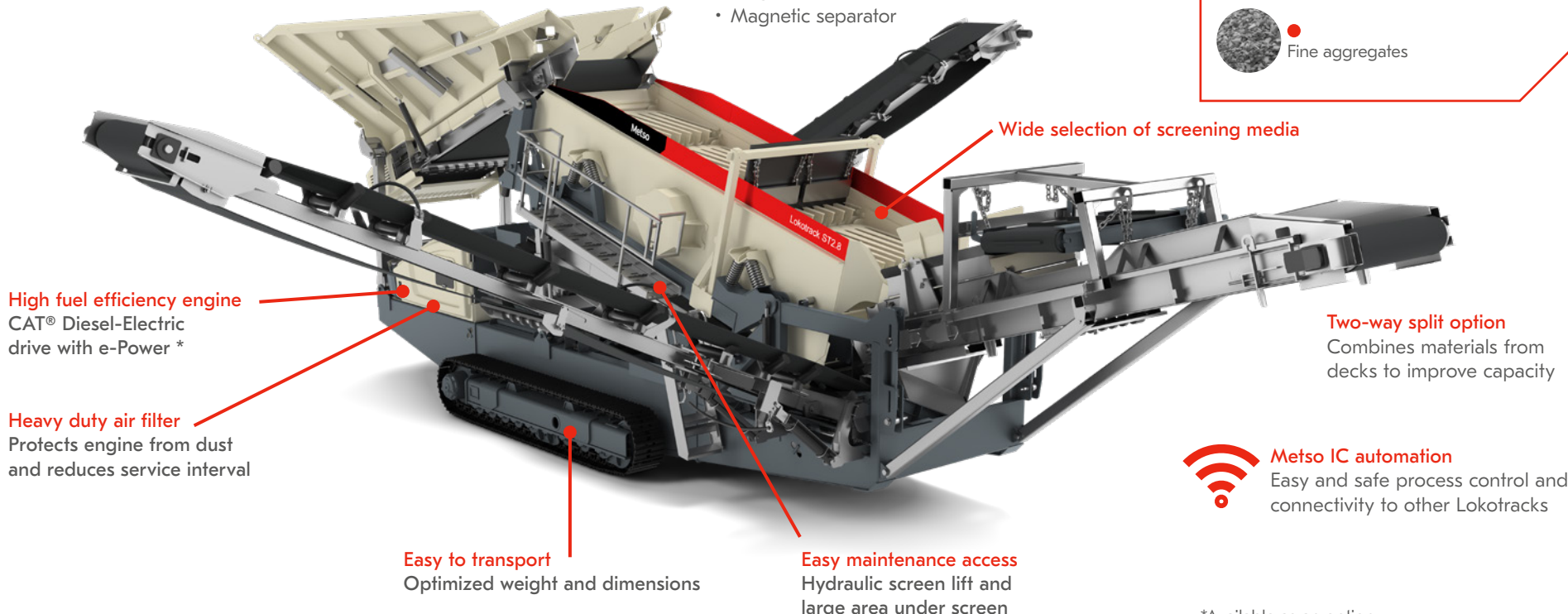

High fuel efficiency engine

CAT® Diesel-Electric drive with e-Power *

Heavy duty air filter

Protects engine from dust and reduces service interval

Easy to transport

Optimized weight and dimensions

Easy maintenance access

Hydraulic screen lift and large area under screen

Wide selection of screening media

Two-way split option

Combines materials from decks to improve capacity



Metso IC automation

Easy and safe process control and connectivity to other Lokotracks

*Available as an option



Biggest stroke for sticky material

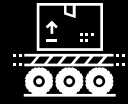

Easy to transport







Easy to use and service



Diesel-electric drive with e-Power

Technical details Lokotrack® ST2.8™ & ST2.8E

Screen	Feeder	Conveyor	Engine power options	Transport dimensions
 <p>Size 4,860 x 1,520 mm (16' x 5')</p> <p>Screening area 7.4 m² (8.9 yd²)</p> <p>Decks 2</p> <p>Nominal capacity* 600 MtpH (660 Stph)</p> <p>Stroke Up to 15 mm</p> <p>Screening media Woven steel mesh, Plate grizzly, Finger grizzly, Punch plate</p>	 <p>Type Belt or Apron feeder</p> <p>Hopper volume 4.5 m³ (5.9 yd³) standard 11 m³ (14.3 yd³) extensions</p> <p>Loading height 3,300 / 3,680 mm (10' 10" / 11' 1")</p> <p>Loading width 3,000 mm (9' 10")</p> <p>Max feed size 600 mm (24")</p>	 <p>Conveyor oversize width 1,200 mm (47")</p> <p>Side conveyor midsize width 800 mm (31,5") Adjustable discharge height</p> <p>Side conveyor undersize width 800 mm (31,5") Adjustable discharge height</p> <p>Under screen conveyor width 1,200 mm (47")</p>	 <p>Model CAT® C3.6</p> <p>StageV/Tier4F 100 kW (134 hp)</p> <p>Tier3 98 kW (131 hp)</p> <p>Fuel tank 300 l (79 gal)</p> <p>Hydraulic oil 105 l (28 gal)</p> <p><i>*Available as an option</i></p>	 <p>Length 15,400 mm (50' 7")</p> <p>Width 3,000 mm (9' 10")</p> <p>Height 3,560 mm (11' 8")</p> <p>Weight 26,000 kg (57,300 lbs)</p>

*Capacity depends on application (required end products, feed material characteristics and size, moisture etc.)



Aggressive stroke for sticky material.



World class expertise for tailored options.



Easy to combine with other Lokotracks.



Lokotrack® ST3.8™ & ST3.8E

Precise screening with high capacity

ST3.8™ is a versatile mobile screen for high capacity aggregates production in quarries or construction sites. It is safe and easy to use and fine-tune to match your operational requirements. The machine is transported as one unit, thanks to hydraulic folding of its conveyors.

10 m side conveyors

- Suspended rollers
- Easier angle adjustment*





Roll-back prevention gates*

Tipping/Vibrating grid
for separating oversize
Tigging grid with rods*

Cost-efficient screening capacity

- Interchangeable screen meshes
- Various screening media

Areas of application:

-  Recycled waste
-  Railway ballast
-  Road base
-  Fine aggregates

Safe by design

Handrails, platforms and lights

Diverter chute

Produce mixed products



Metso IC automation

Easy and safe process control and connectivity to other Lokotracks

Fuel efficient Engine

CAT® Diesel-Electric drive
with e-Power *

Easy maintenance access

- Hydraulic screen lift
- Large area under screen

*Available as an option



Easy fine-tuning to match your
operational requirements



Quick adaptation with
interchangeable screen meshes

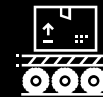





Compact size for transport
in a standard trailer



Diesel-electric drive
with e-Power

Technical details Lokotrack® ST3.8™ & ST3.8E

Screen	Feeder	Conveyor	Engine power options	Transport dimensions
 <p>Size 5,480 x 1,520 mm (18' x 5')</p> <p>Screening area 8.4 m² (10 yd²)</p> <p>Decks 2</p> <p>Nominal capacity* 500 Mtph (550 Stph)</p> <p>Stroke 7-8 mm</p> <p>Screening media Woven steel mesh</p>	 <p>Type Belt feeder with tipping/ vibrating grid or rock box</p> <p>Hopper volume 7.5 m³ (9.6 yd³)</p> <p>Loading height 2,315 mm (7' 7") 3,390 mm (11' 1") (with tipping grid)</p> <p>Loading width 4,650 mm (15' 4")</p> <p>Max feed size 150 mm (6")</p>	 <p>Lifting conveyor width 1,050 mm (42")</p> <p>Side conveyor top deck* width 800 mm (31,5") length 10 m (32' 10")</p> <p>Side conveyor bottom deck* width 800 mm (31,5") length 10 m (32' 10")</p> <p>Product conveyor undersize width 1,200 mm (47")</p> <p>*Adjustable discharge height</p>	 <p>Model CAT® C3.6</p> <p>StageV/Tier4F 100 kW (134 hp)</p> <p>Tier3 106 kW (142 hp)</p> <p>Fuel tank 300 l (79 gal)</p> <p>Hydraulic oil 105 l (28 gal)</p> <p>*Available as an option</p>	 <p>Length 18,000 mm (59' 1")</p> <p>Width 3,000 mm (9' 10")</p> <p>Height 3,330 mm (10' 11")</p> <p>Weight 30,000 kg (66,100 lbs)</p>

*Capacity depends on application (required end products, feed material characteristics and size, moisture etc.).



Multiple options for feeding.



Interchangeable screen meshes.



Easy access to the service locations.



Safety by design.



"Because every bit of material we have to move or crush will be used on the site, we looked at all the competitor mobile plants with Chris. Because we knew what needed to be done, we both agreed we needed the best. We wanted Metso Lokotracks,"
McDonald, Highways, Inc., Tennessee, USA

Lokotrack® ST4.8™ & ST4.8E

An easy to transport triple deck screen

ST4.8™ provides precise, high capacity screening. The screen meshes are easily interchangeable, the conveyors are hydraulically foldable for easy transport, and the e-Power feature makes it efficient in both standalone and multi-stage applications.

Areas of application:

-  Recycled waste
-  Railway ballast
-  Road base
-  Fine aggregates

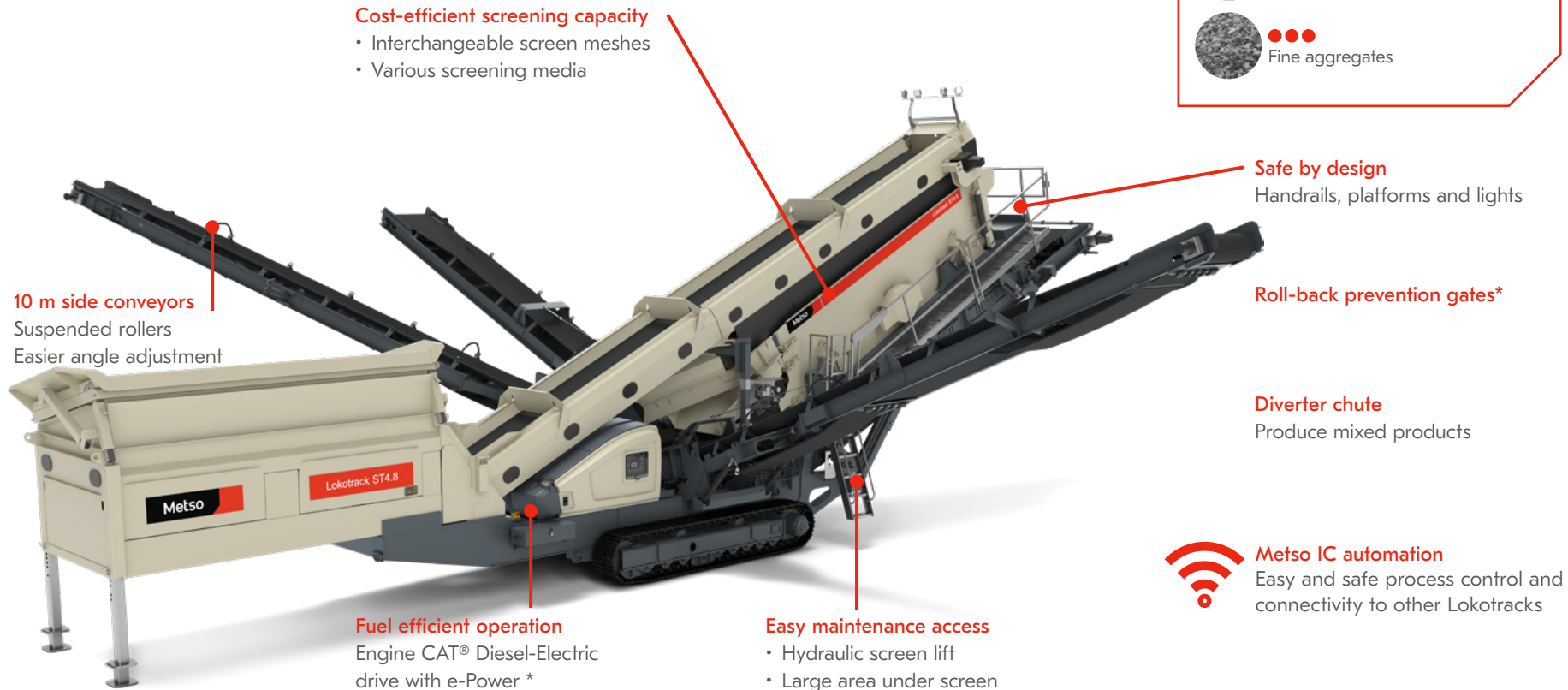

 **Metso IC automation**
Easy and safe process control and connectivity to other Lokotracks

*Available as an option



Easy fine-tuning to match your operational requirements



Quick adaptation with interchangeable screen meshes

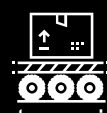





Transport as a single unit



Diesel-electric drive with e-Power

Technical details Lokotrack® ST4.8™ & ST4.8E

Screen	Feeder	Conveyor	Engine power options	Transport dimensions
 <p>Size 5,480 x 1,520 mm (18' x 5')</p> <p>Screening area 8.4 m² (10 yd²)</p> <p>Decks 3</p> <p>Nominal capacity* 500 Mtph (550Stph)</p> <p>Stroke 7-8 mm</p> <p>Screening media Woven steel mesh</p>	 <p>Type Belt feeder with tipping/ vibrating grid or rock box</p> <p>Hopper volume 7.5 m³ (9.6 yd³)</p> <p>Loading height 2,315 mm (7' 7") 3,390 mm (11' 1") (with tipping grid)</p> <p>Loading width 4,650 mm (15' 4")</p> <p>Max feed size 150 mm (6")</p>	 <p>Lifting conveyor width 1,050 mm (42")</p> <p>Side conveyor top deck* width 650 mm (26") length 10 m (32' 10")</p> <p>Side conveyor midsize* width 800 mm (31,5") length 10 m (32' 10")</p> <p>Side conveyor bottom deck* width 800 mm (31,5") length 10 m (32' 10")</p> <p>Product conveyor undersize width 1,200 mm (47")</p> <p>*Adjustable discharge height</p>	 <p>Model CAT® C3.6</p> <p>StageV/Tier4F 100 kW (134 hp)</p> <p>Tier3 106 kW (142 hp)</p> <p>Fuel tank 300 l (79 gal)</p> <p>Hydraulic oil 105 l (28 gal)</p> <p>*Available as an option</p>	 <p>Length 18,000 mm (59' 1")</p> <p>Width 3,040 mm (9' 11")</p> <p>Height 3,560 mm (11' 8")</p> <p>Weight 32,000 kg (70,500 lbs)</p>

*Capacity depends on application (required end products, feed material characteristics and size, moisture etc.)



Washing equipment as a standard option.



High capacity with 4 end products.



Fine-tune to match your operation.



Adjustable conveyors for high stockpiles.



Lokotrack® ST4.10™ & ST4.10E

High capacity mobile screen for closed circuit crushing

ST4.10™ is ideal for large-scale aggregate production where closed circuit process is used for producing aggregates for concrete and asphalt sands, road base and building foundations.

Adjustable side conveyor height and angle
Easier closed circuit and high stockpiles

Easy mesh change
Side tensioned top & middle deck

Areas of application:

-  Recycled waste
-  Railway ballast
-  Road base
-  Fine aggregates

Wide feed box
Easier wheel loader feeding and closed circuit process

Safe by design
Handrails, platforms and lights

Diverter chute
Mix products from different decks

Easy maintenance
Top and middle deck side tensioned
Hydraulic screen lift

 **Metso IC automation**
Easy and safe process control and connectivity to other Lokotracks

Fuel efficient operation
Engine CAT® Diesel-Electric drive with e-Power *

Heavy-duty air filter
Protects engine from dust and reduces service interval

*Available as an option

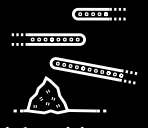

Extended feed hopper for easy closed-circuit production



Transport as a single unit







Easy mesh changes by a single person



Diesel-electric drive with e-Power

Technical details Lokotrack® ST4.10™ & ST4.10E

Screen	Feeder	Conveyor	Engine power options	Transport dimensions
 <p>Size 6,060 x 1,520 mm (20' x 5")</p> <p>Screening area 9,3 m² (10.8 yd²)</p> <p>Decks 3</p> <p>Nominal capacity* 600 Mtph (660 Stph)</p> <p>Stroke 8-9 mm</p> <p>Screening media Woven steel mesh Trellex rubber mesh</p>	 <p>Type Belt feeder with tipping/ vibrating grid or rock box</p> <p>Feed hopper volume 8 m³ (10 yd³)</p> <p>Loading height 3,390 mm (11' 1") (with tipping grid)</p> <p>Loading width 4,650 mm (15', 3")</p> <p>Max feed size 150 mm (6")</p>	 <p>Lifting conveyor width 1,050 mm (42")</p> <p>Side conveyor top deck* width 650 mm (26") length 10 m (32' 10")</p> <p>Side conveyor midsize* width 800 mm (31,5") length 10 m (32' 10")</p> <p>Side conveyor bottom deck* width 800 mm (31,5") length 10 m (32' 10")</p> <p>Product conveyor undersize width 1,200 mm (47")</p> <p>*Adjustable discharge height</p>	 <p>Model CAT® C3.6</p> <p>StageV/Tier4F 100 kW (134 hp)</p> <p>Tier3 106 kW (142 hp)</p> <p>Fuel tank 300 l (79 gal)</p> <p>Hydraulic oil 105 l (28 gal)</p> <p>*Available as an option</p>	 <p>Length 19,650 mm (64' 2")</p> <p>Width 3,040 mm (10')</p> <p>Height 3,560 mm (11' 1")</p> <p>Weight 33,000 kg (72,700 lbs)*</p>

*Capacity depends on application (required end products, feed material characteristics and size, moisture etc.).



Transport as a single unit.



Adjustable conveyor heights for flexible operations.



e-Power for efficient hybrid diesel-electric operation.



Large feed box allows closed circuit process.



"When such volumes are being produced by a single crushing plant, the machinery needs to be reliable. Metso is known as a dependable Finnish company that also provides well-functioning maintenance services."

Jari Pärhä, Pärhä Oy

Examples of Lokotrack® ST applications



Topsoil and landscaping screening with Lokotrack® ST2.8™.

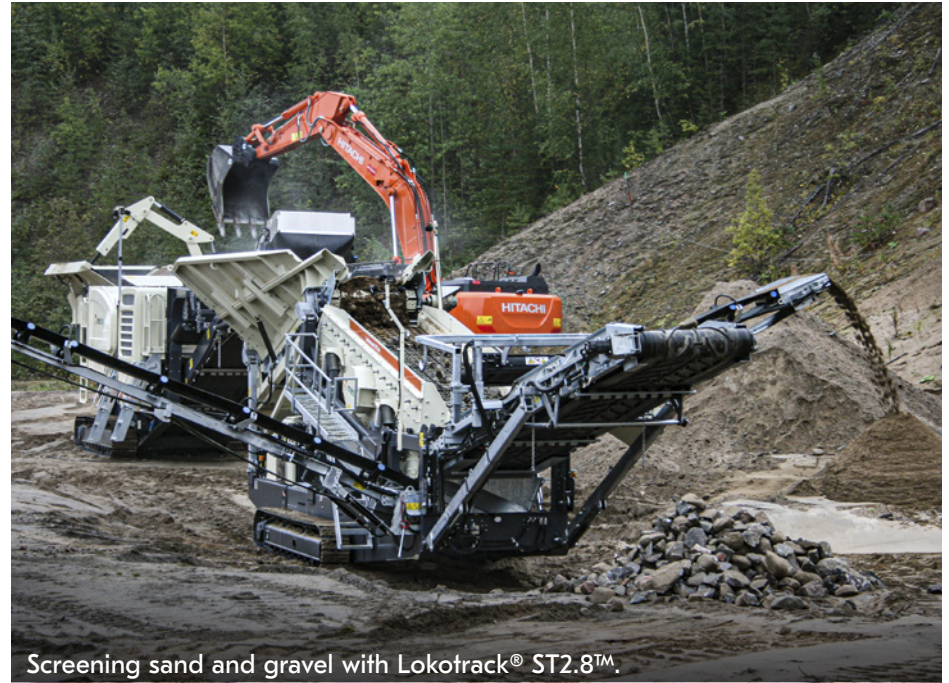

Screening sand and gravel with Lokotrack® ST2.8™.

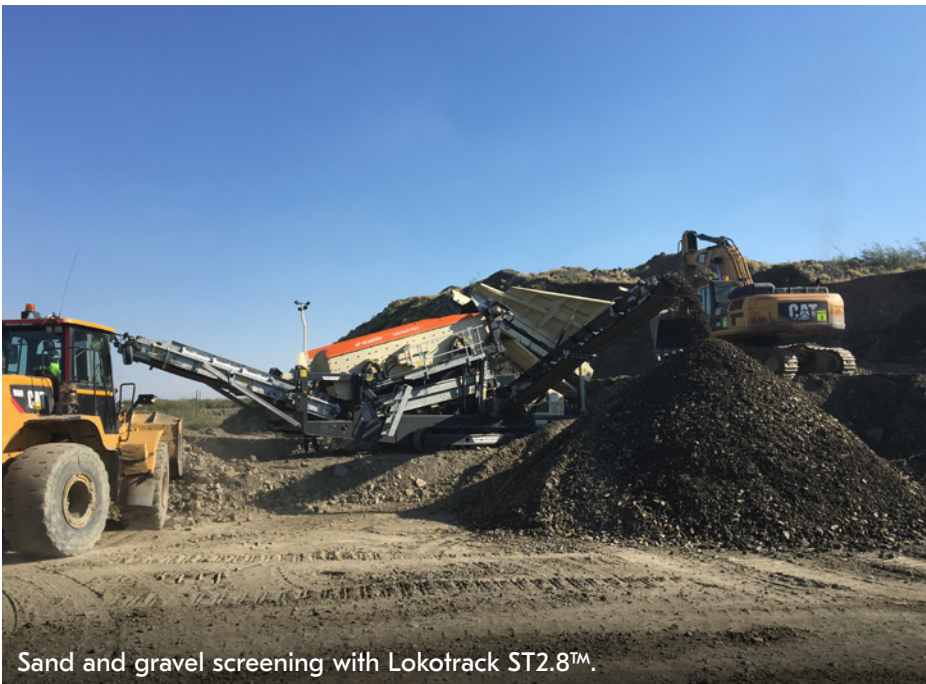

Sand and gravel screening with Lokotrack ST2.8™.



Screening recycled concrete with Lokotrack® ST2.3™.



"I don't care if you make the best equipment in the world, it's worthless unless you can support it, fix it, help the customer fix it, and operate it efficiently."

Duff Boyd, Riverbend Construction Services, North Carolina, USA

Metso expert support, parts and services

Rely on genuine Metso OEM wear and spare parts to minimize maintenance issues and ensure long-lasting productivity. Our global network of Metso distributors and logistics warehouses ensure that OEM spare and wear parts are available when you need them. With both standard and engineered-to-order parts, we can ensure that you have the support your mobile screens need.

- Global Metso support and service
- Genuine Metso parts
- Improved equipment reliability
- Global availability
- A wide selection of screening media

Case Story



NCC Bornholm modernizes their operations with a Lokotrack ST2.8

"ST2.8 has been designed to meet the requirements of demanding primary crushing, and it's ideal for processing crushed rock material," says, Jørgen V. Nielsen, Project Manager, Dansk Grusgrav Materiel ApS.

Read the full story at: metso.com/insights/case-studies

Case Story



C & H Paving reduced costs with a multi-stage Lokotrack solution

"Every piece we bought was mobile. Everything talks to one another, and it just makes more production. And at the end of the day, it saves labor and time for everybody," says Benji Cranford, owner of C & H Paving.

Read the full story at: metso.com/insights/case-studies

Case Story



Pärhä Oy upgrade their crushing operations

"A high level of quality and an even production wouldn't be possible without our experienced and professional personnel. I'd like to thank our entire team," says Jari Pärhä, Director of Crushing Operations.

Read the full story at: metso.com/insights/case-studies

Metso is a frontrunner in providing sustainable technologies, end-to-end solutions and services for the aggregates, minerals processing and metals refining industries globally. By helping our customers increase their productivity, improve their energy and water efficiency and environmental performance with our process and product expertise, we are the **partner for positive change**.

[metso.com](https://www.metso.com)

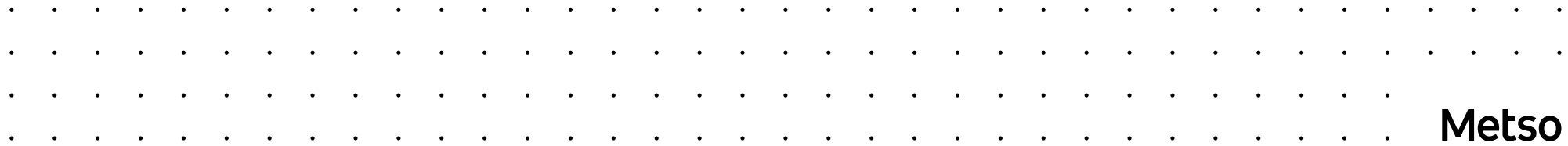

Metso